

Alibre Design Tutorial - Simple Revolve Translucent Glass Lamp Globe

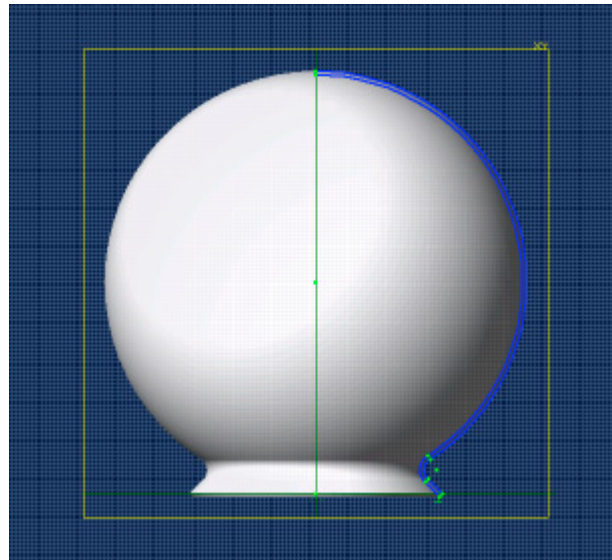

Part Tutorial

Exercise 2: Globe-1

**In this Exercise, We will set System Parameters first.
Then, in sketch mode, we will first Outline the Bowl with Arcs & Straight Lines.
Then we will use the Revolve Feature to create the Bowl.**

Launch Alibre Design.

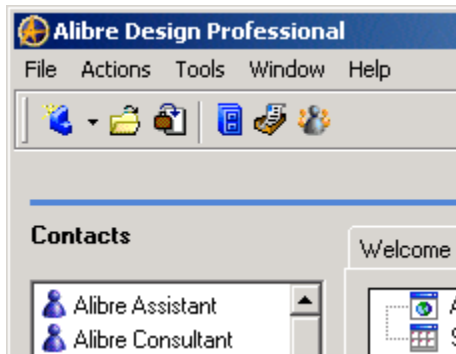
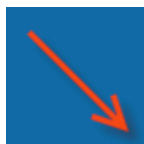

From the Home window - select File, Work Offline.

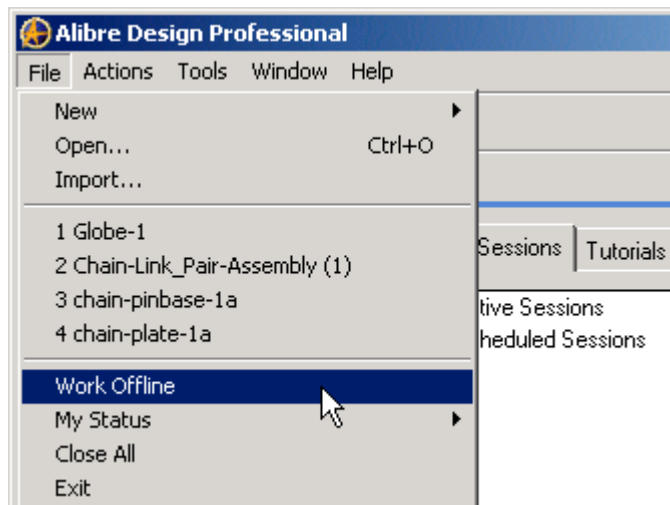

Open a New Part workspace. From the Home window - select File, New, Part.

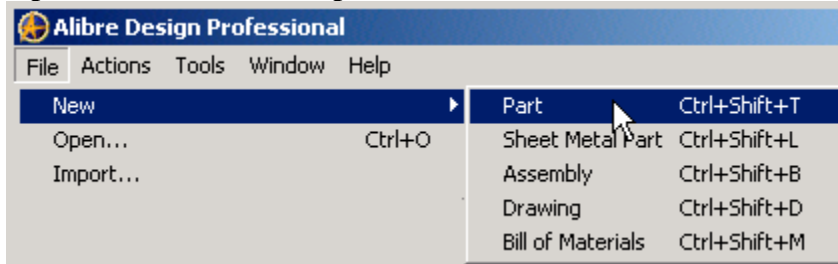

Maximise the Part Workspace Window.

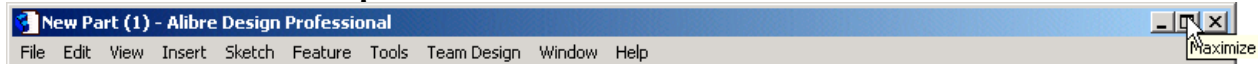

Set Design Properties.

Select File, Properties.

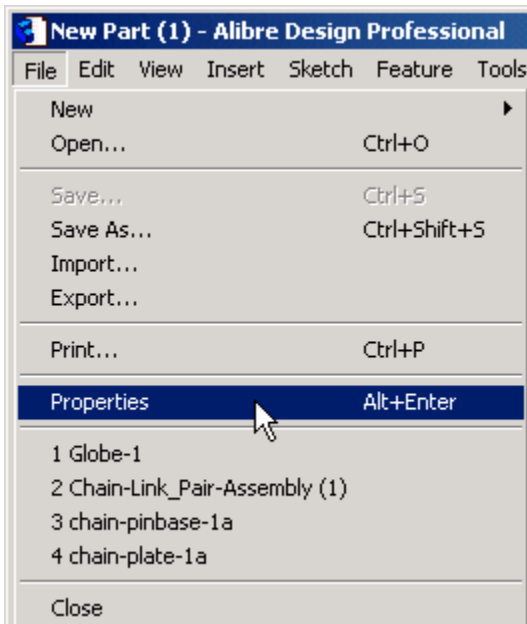

A) Select the Tab Marked "General"

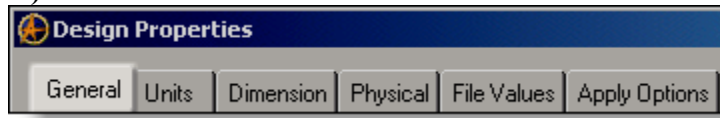

- In Description: insert the information: 'Translucent Glass Lamp Globe'.
- In Curve Smoothness, Select the Radio Button marked 'Automatic'.

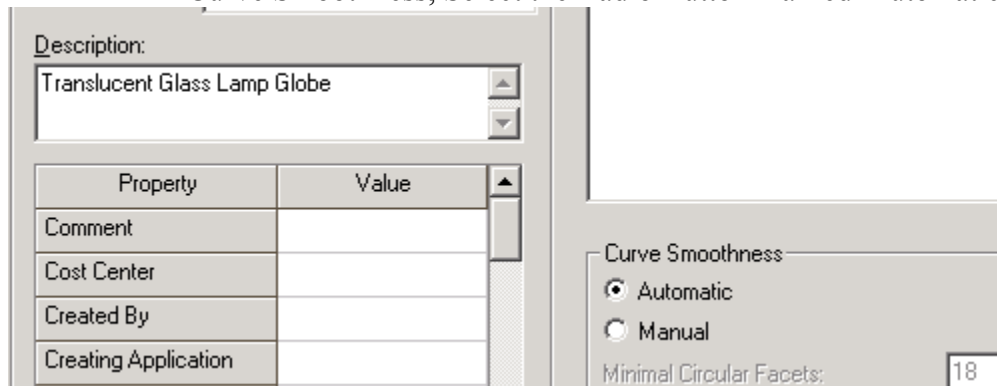

B) Select the Tab Marked "Units"

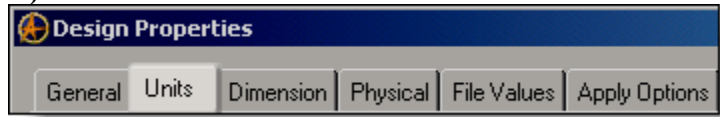

- Check off the Box 'Show Units for Dimensions'.



- On 'Display Units' - confirm **Unit: Inches**, **Format: Decimals** and **Precision: 4**. Adjust if not.
- On 'Angle' - Confirm **Angle: Degrees** and **Precision: 4**. Adjust to these parameters if not.

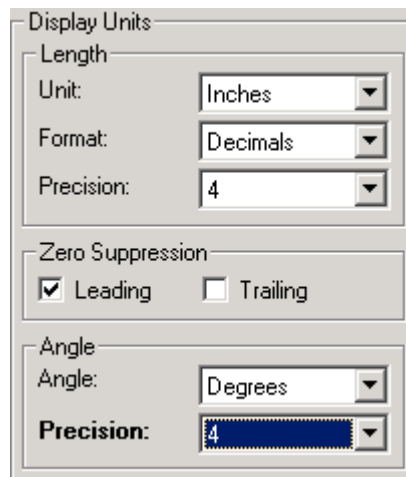
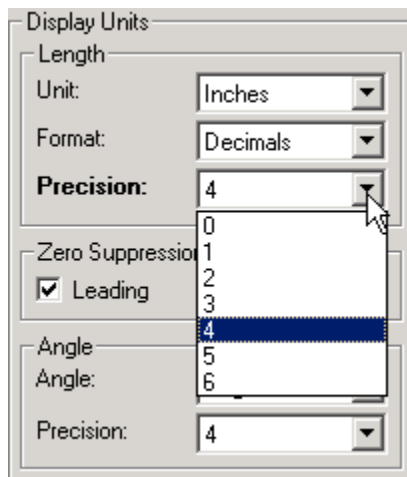

- On 'Spinner Increment' - for 'Length:' enter .0500 " and for 'Angle:' enter 0.5000 degrees. Adjust to these parameters if not. Press 'Tab' to move after editing them.

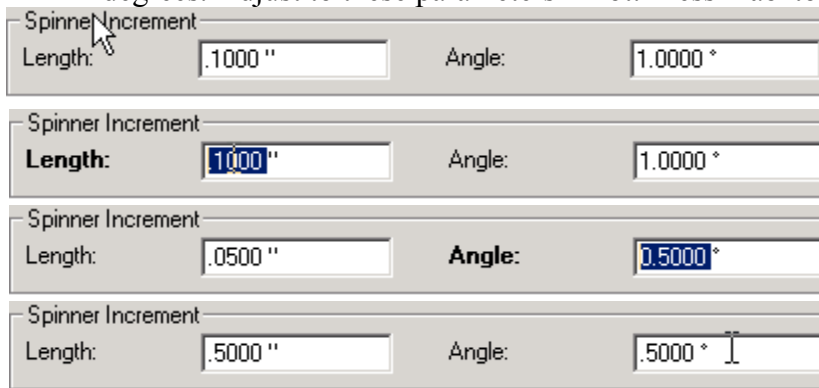

C) Select the Tab marked 'Physical'

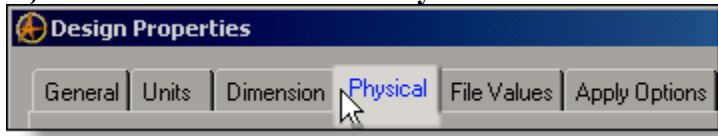

- Change 'Accuracy:' to Low.

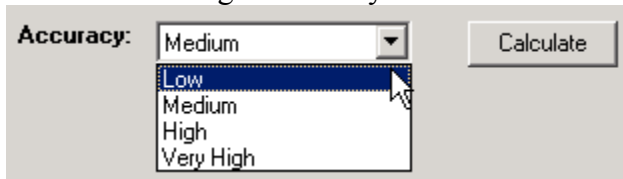

- Click on the 'Calculate' Button. Notice the results.

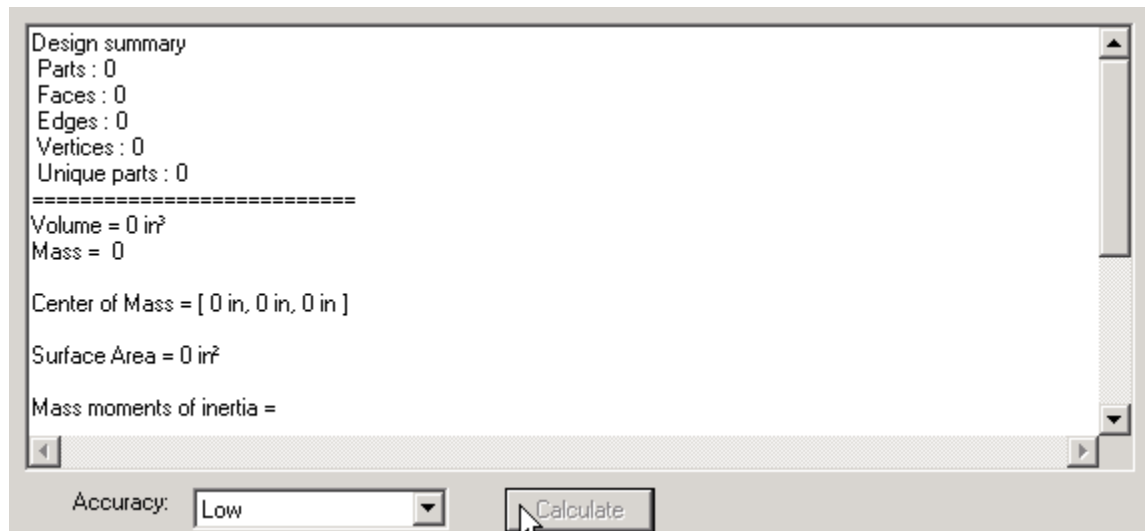

D) Select the Tab marked "Apply Options"

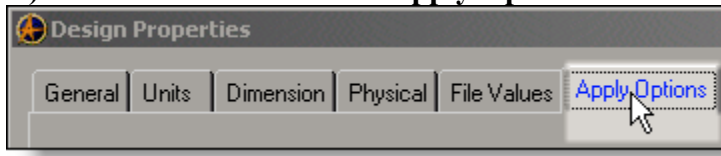

- On 'Apply Changes to' - Click the Radio Button beside 'The Current Document'

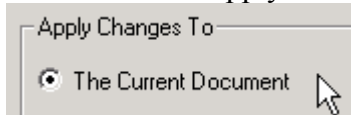

- Click "Apply", then Click Close.



Set Part Options.

From Top Text Menu - Select - Tools > Options: >

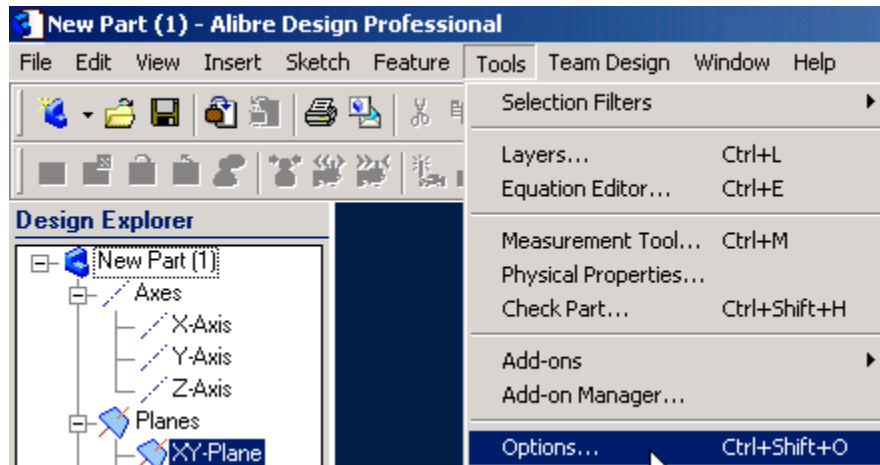

General Tab > Select or confirm checked off are:

Global - Show popup on errors,

Hints - All

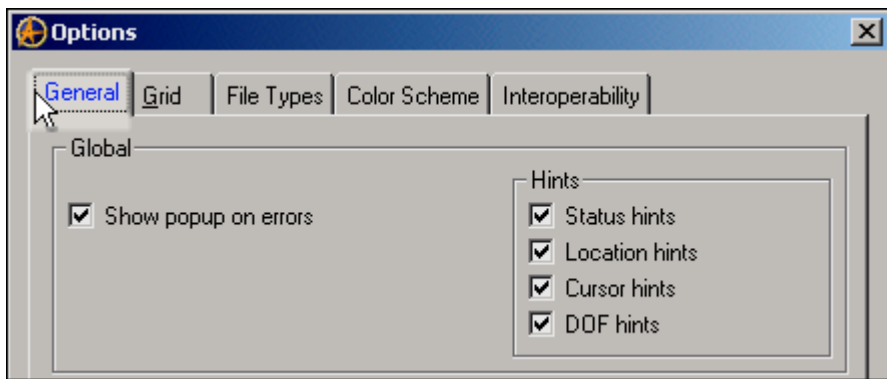

Design

- Prompt for newer versions, - Snap to working plane, - Prompt to edit sketch,
- Prompt on detecting parameters with missing external link, - Reorient on extrude,
- Keep model in View, - Prompt when not sketching on face.

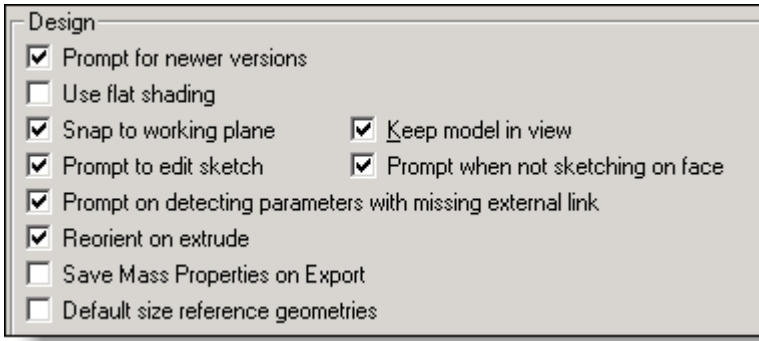

Show as Default - Planes, Annotations, and Sketches.

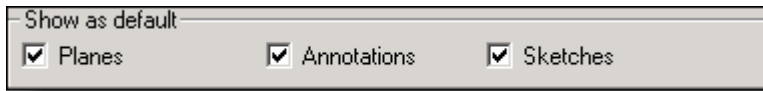

Grid Tab> Spacing: Make X: 0.0500 " and Y: 0.0500 ", check off Display Grid, and Snap to Grid.

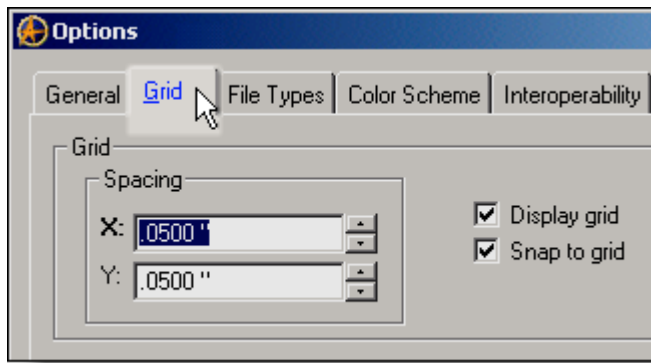

Color Scheme Tab>

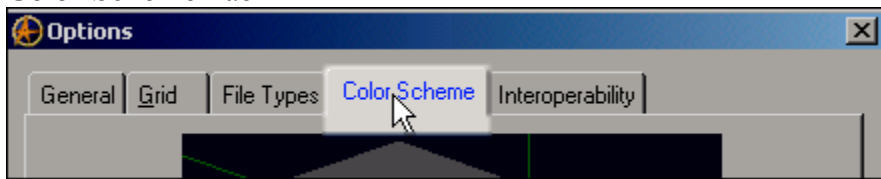

For 'Scheme:' - confirm - Dark Background Scheme. Click 'OK'.

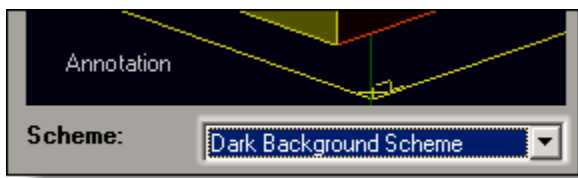

Start the Profile Sketch.

From the Top Text Menu - Select Sketch > Activate Sketch.

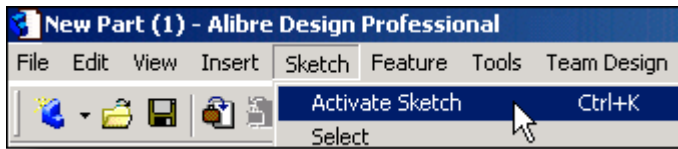

From the Top Text Menu - Select Sketch > Figures > Line.

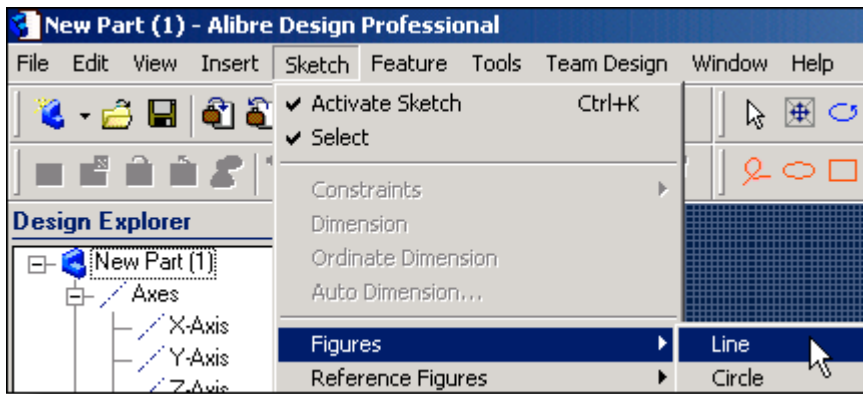

- Locate the Origin, click - move right 1.5" along the 'X-axis' and double click.

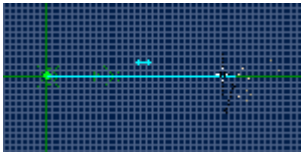

Note the lower right hand corner of the workspace: (1.50, .00) this is the 'X' distance and 'Y' distance of this line from the origin.

(1.50, .00)

- Select - From the Top Text Menu - View > Zoom > Zoom to Fit.

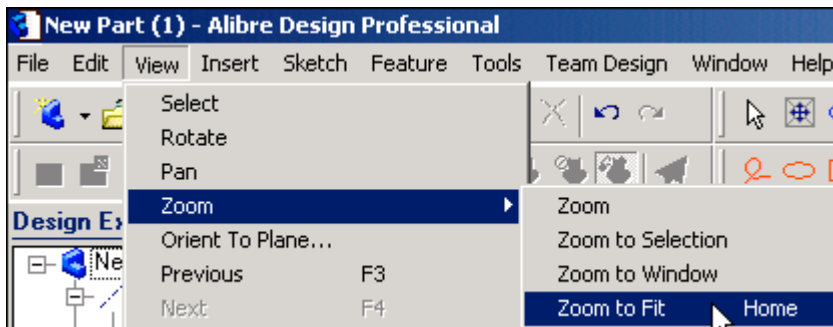

Click on the finishing end of this line (Still in Line mode); drag up three grid squares (0.1500")



[1.50, .15]

- And left one Grid Square (0.0500"), double click.

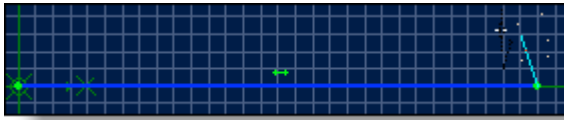

[1.45, .16]



- Select - from the Top Text Menu - Sketch > Dimension.

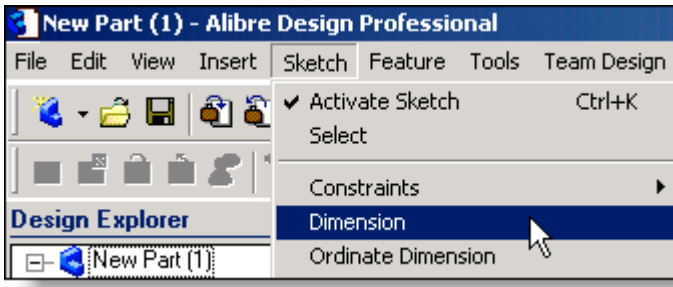

- Select the first line along its length,

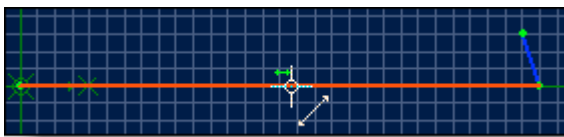

drag down slightly to locate the Dimension,

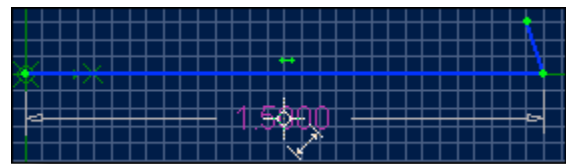

click,



then press Enter.

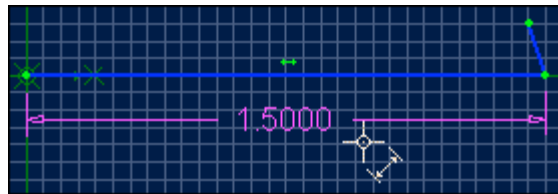

- Select the first line, press the 'shift' key and hold, select the second line.

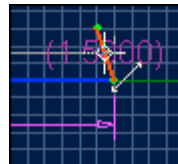
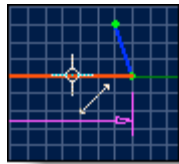

- Drag the mouse slightly up and in to the center of the angular space, click.



- Select all the numbers in the selection box, and Type 45.0 - press Enter.

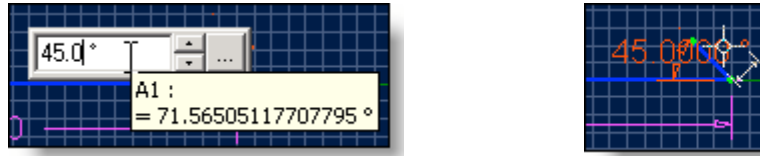

- Select the now 45 degree angling Line, drag up and to the right slightly, click.

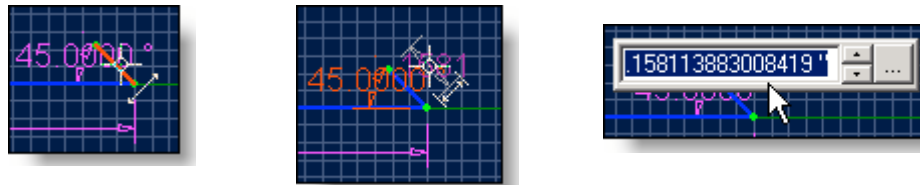

- Edit the Numbers to 0.5000". Enter.

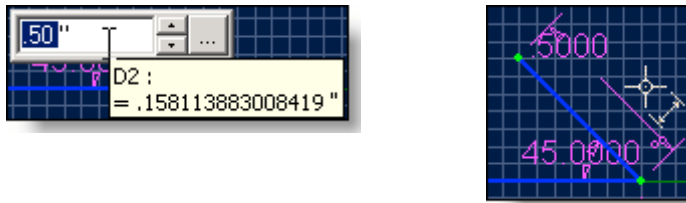

- Select the Annotations of the Dimensions and drag them from between the dimension lines, out of the way.

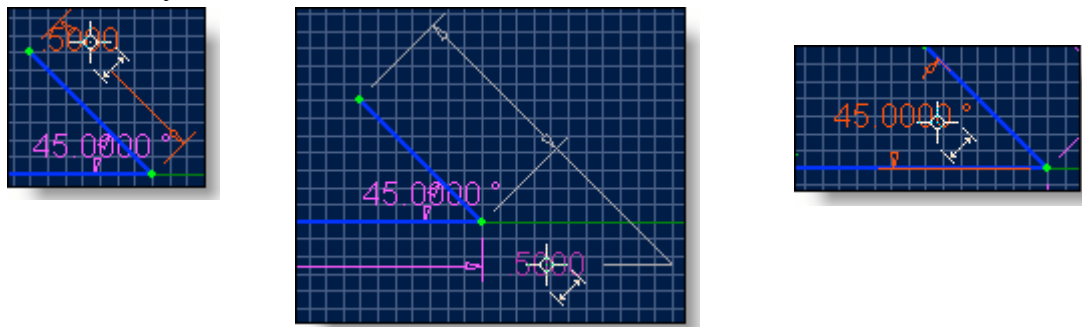

- Select **Zoom to Fit** from the Top Row of Icons (Magnifying Glass with Document). Click.

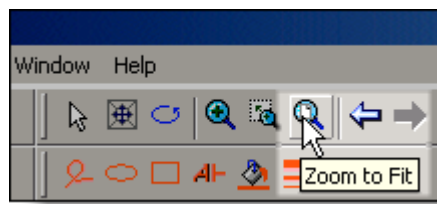

- Select **Zoom Mode** from the top Row of Icons (Magnifying Glass with '+'). Click.

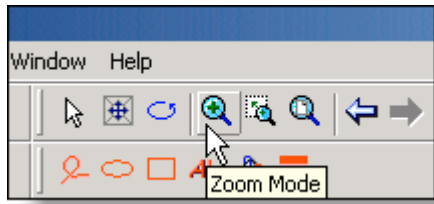

- Click in the work area near top, and drag down to zoom out.

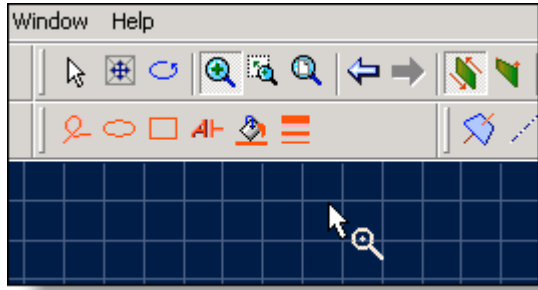

- Adjust the size of the base line to allow it to be about screen center.
- From the Right Hand two columns of Icons, Select the '**Line**' Icon from the inside Column (Sketch Menu Icons). Click.



- From the Origin, Click and Place a Vertical Line (90 Degrees) up the 'Y-Axis' 5.5000". Double Click.

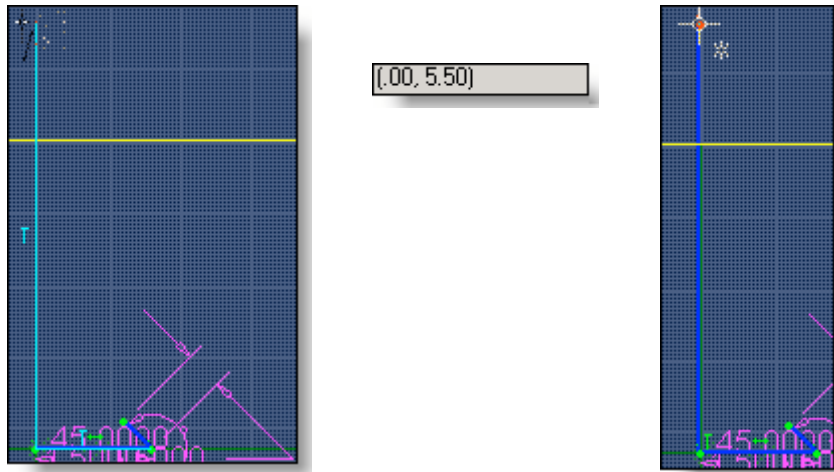

- Place a Horizontal Line approximately mid-way up the vertical line but not touching it. Make it about 1.0".

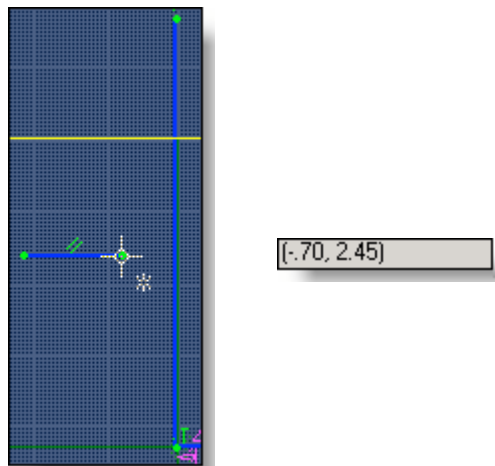

- On the Same Column of Icons, select the fly-out triangle on the Third Icon from the Top, (**Options**), Select the 5th Icon from the Right - '**Midline Constraint**.'

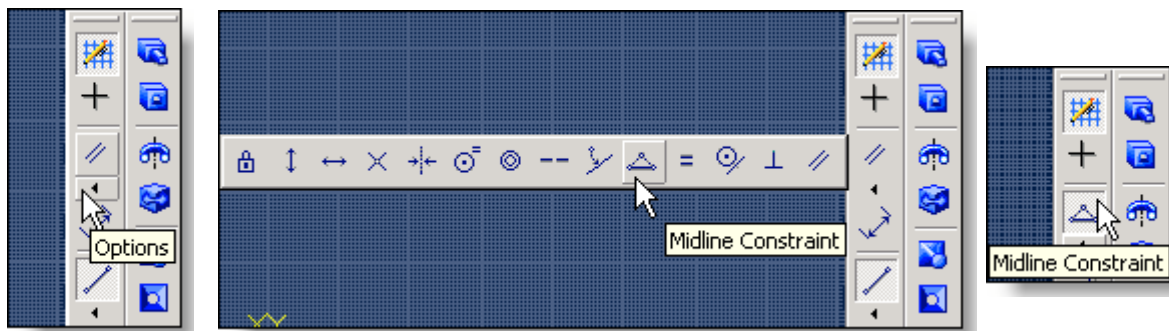

- Select the Vertical Line, Click it, (It becomes Yellow as you move the cursor away),

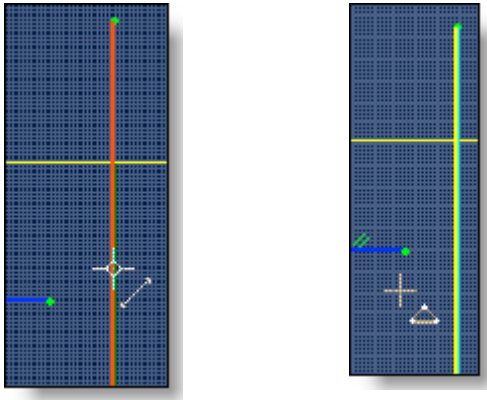

- Hold 'Shift' and Select the point at the end of the Horizontal line just placed. The line will move to the exact mid point of the vertical line.

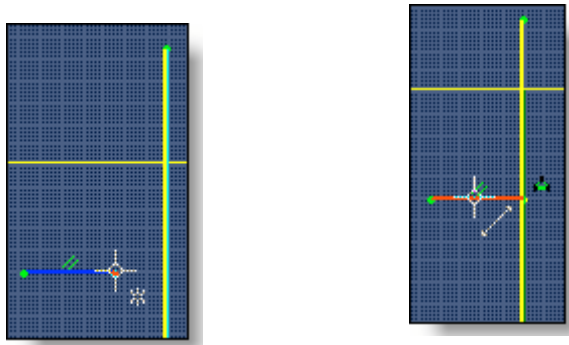

- Click in open space in the work area to de-select the Vertical Line.

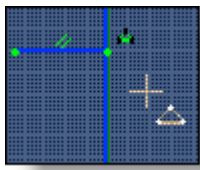

- From the Sketch Icons, Select 'Circular Arc - Center, Start, End'.

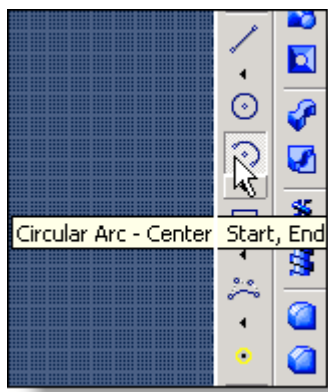

- Click on the Vertical Line Mid Point, then at the Top of the Vertical Line, then Sweep an Arc down to the Right, selecting the Bottom of the Vertical Line - at the Origin,

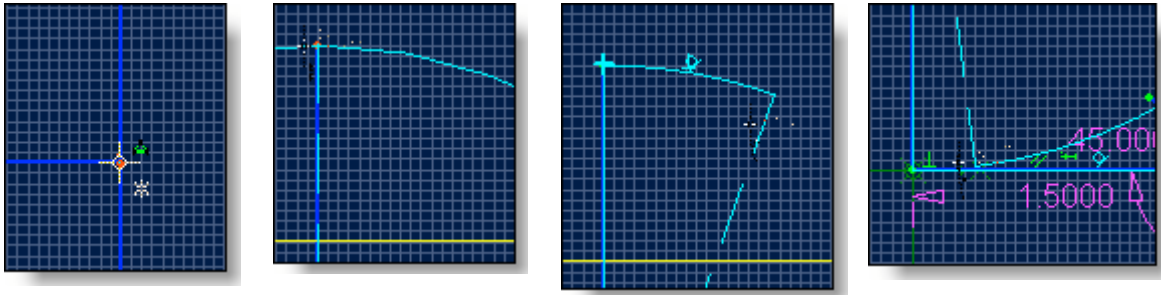

- Click.

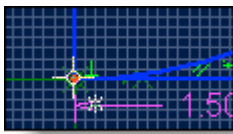

- Select Zoom to Fit from the Top Row of Icons (Magnifying Glass with Document). Click.

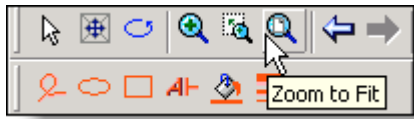

- Select - from the Top Text Menu - Sketch > Select. Click. (Note the Select 2nd Down Icon in the Sketch Menu Icons).

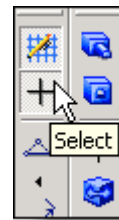
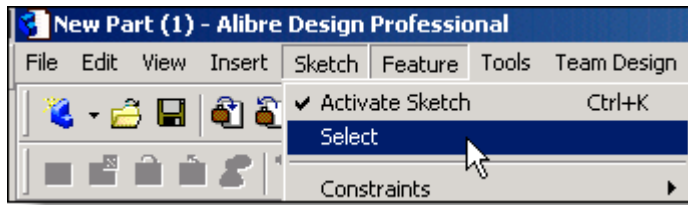

- Select the Horizontal Line at the Mid Point of the Vertical Line, Click. Press the Delete Key.

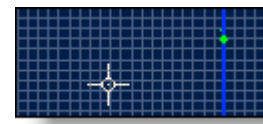
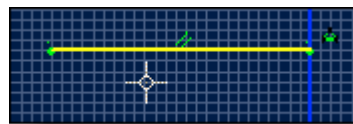
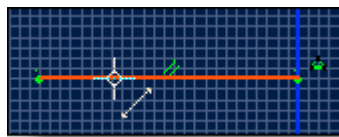

- Select - from the Top Text Menu - Sketch > Trim.
(Note the **Trim Figure** Icon, 6th up in the Sketch Menu Icons).

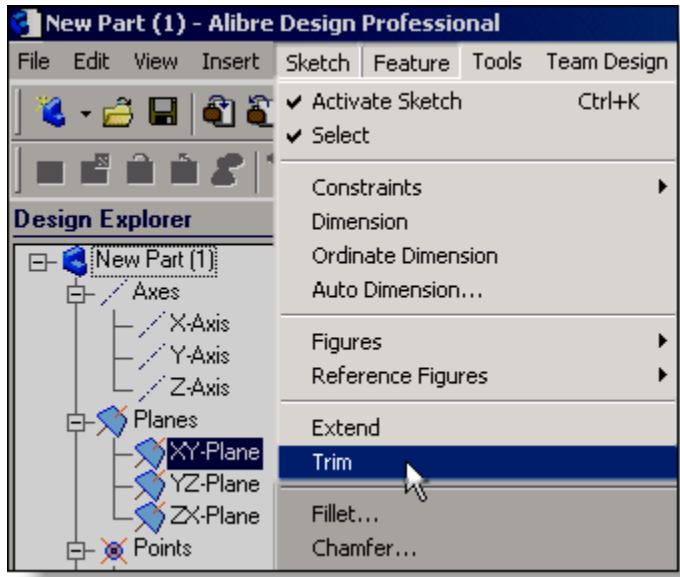

- With Trim Activated, Select the Lowest portion of the Arc between the 45-Degree Line and the Origin. Click.

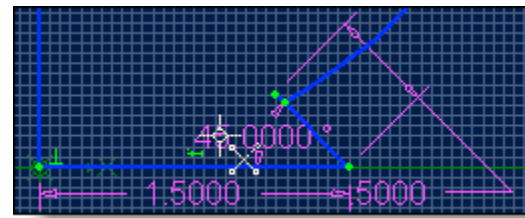
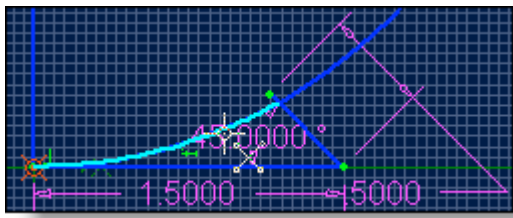

- In the Top Icons, Select **Zoom to Window** Icon (Magnifying Glass with an Arrow).

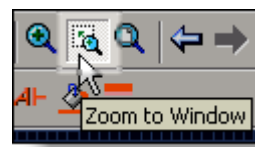

- Select a Window area around the now bottom of the arc and the 45 Degree Line.
(Click, Drag, Release).

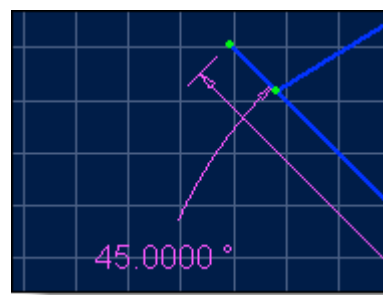
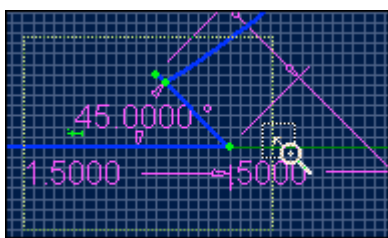

- With Trim Still Activated, Select the overhanging end of the 45-Degree Line. Click.

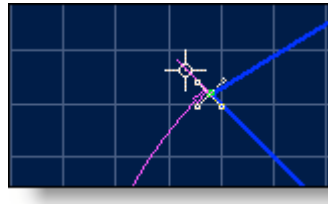
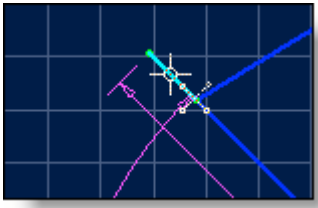

- Just below the Activated 'Trim' Icon, Select **2D Fillet**. The Fillet Figures Popup appears.

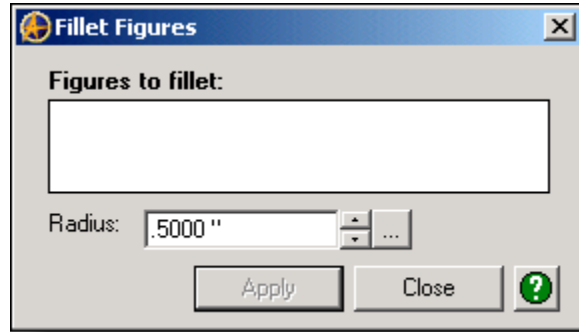

- Click the Bottom of the Arc, Shift Click to select the 45-Degree Line.

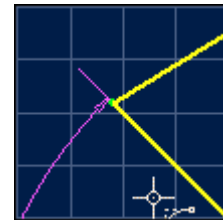
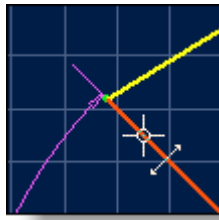
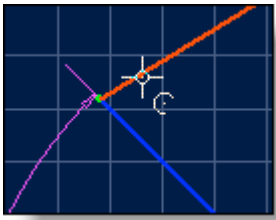

In the Fillet Figures Popup, see 'Figures to fillet' - Circular Arc<6> and Line<7>.

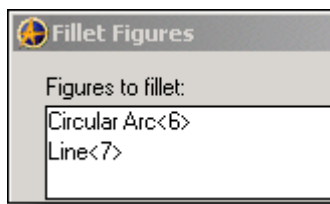

- Set the Radius at .1500 " by clicking the down arrow selection. Click 'Apply'. Click 'Close.'



- Observe the now Filleted Intersection of the Arc and Line:

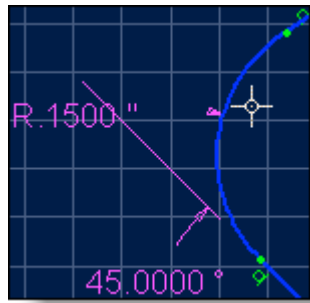

- Select the 'Select' Icon in the Sketch Menu Icons.



- Click the Annotation 'R.1500 "' and drag to re-locate the figure into clear space.

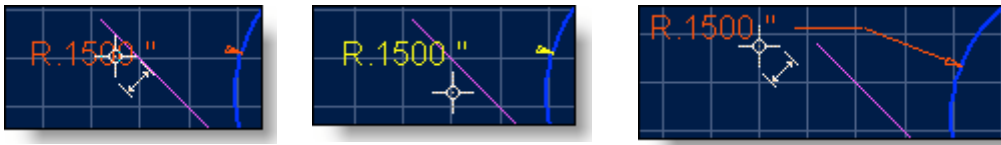

- Select 'Offset' Icon in the Sketch Menu Icons. (3rd up from Bottom). Edit Distance to .0500 "

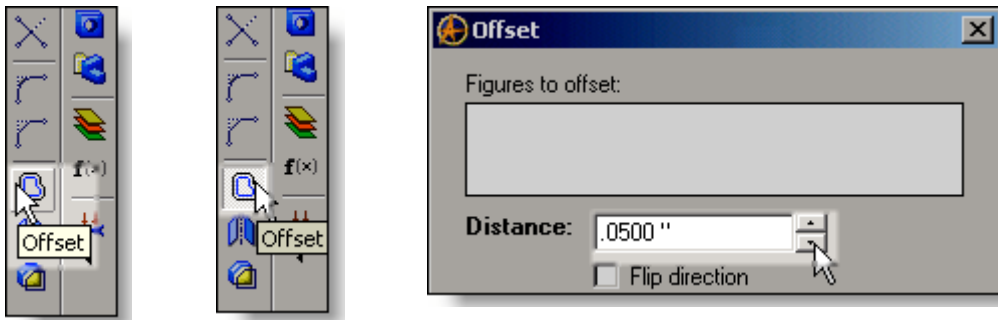

- Select: 45-Degree Line, Fillet Arc, and Upper Arc. (Hold Shift for 2nd and 3rd selections).

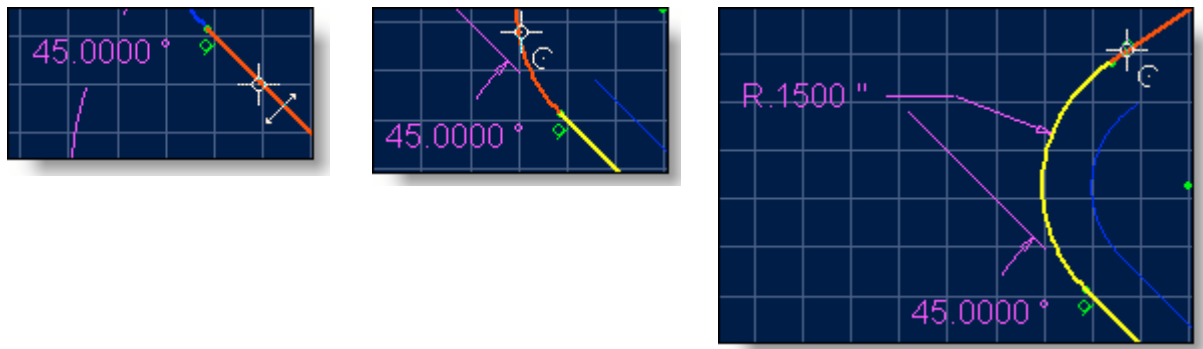

In the Figures to offset: Line<7>, Circular Arc<8>, Circular Arc<6>.

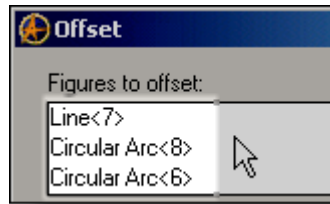

- If the Offset line is outside, click the Box beside 'Flip direction'. Observe offset lines move.

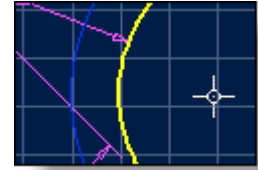
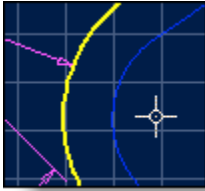

- Leave 'Gap Type' set at 'Natural'. Click 'OK'.

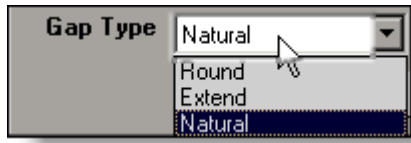

- Select the **Line** Icon. Connect a line between the inside and outside 45-Degree Lines.

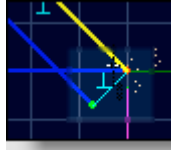

- Select **Zoom to Fit**. Click.



- Select the '**Select**' Icon in the Sketch Menu Icons.



- Select the Horizontal Line on the 'X-Axis'. Select Delete.



- Select the Trim Icon, and Trim the Vertical Line, selecting between the Origin and the inside Offset Line. This will trim the long line, leaving inside and outside Arcs connected. **Click.**

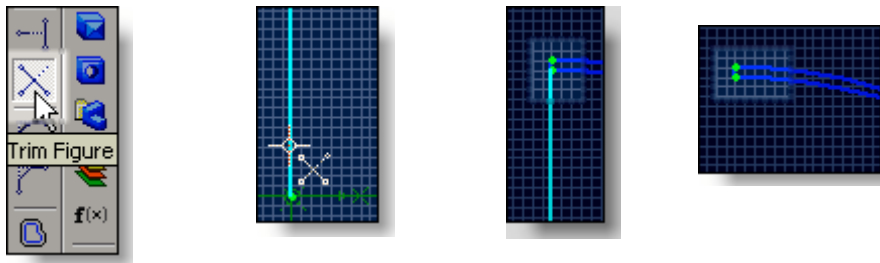

- If you get a **Confirm Trim Figure** popup, click **Yes**.

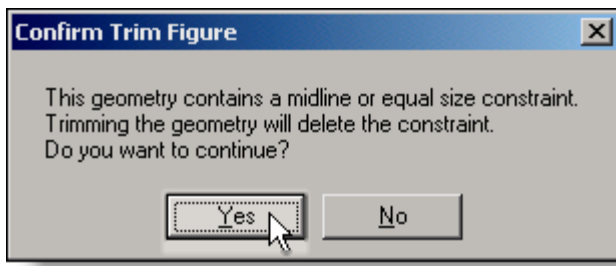

- Select - from the Top Text Menu - Sketch > Analyse.

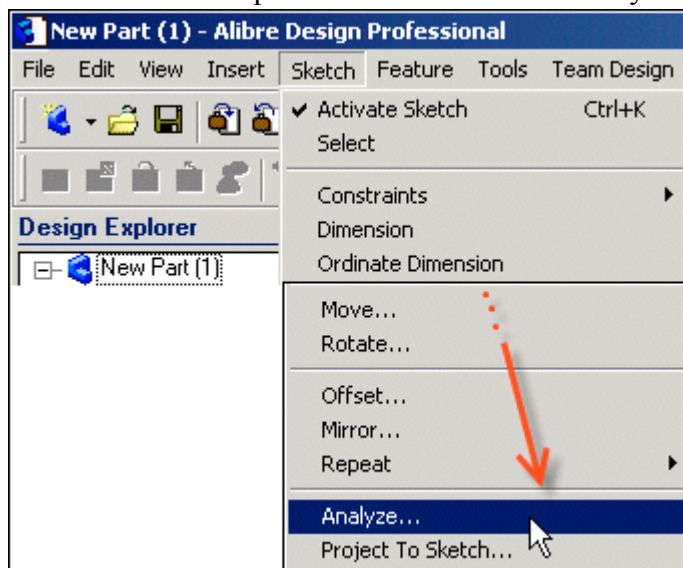

Click the 'Analyse' Button

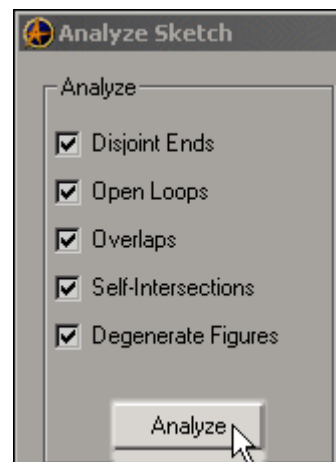

- Observe the message below the 'Analyse' Button:
'No potential problems detected in the sketch for the current check levels...' Click 'Close'.

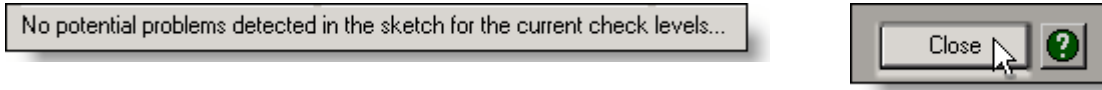

- Select Zoom to Fit. Click. You should have this image. (Sample scaled to 33%)

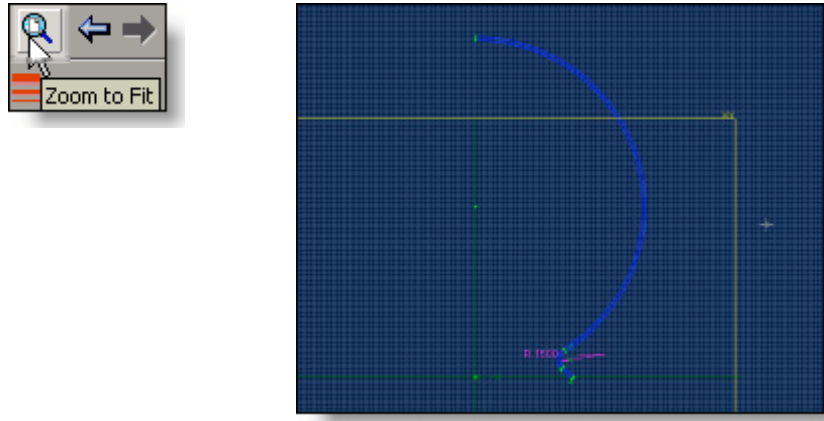

- You have now completed the Sketch for this Revolve Globe. Continue on to the Revolve Feature to complete it.

Create the Revolve Globe from the Profile Sketch.

- Select - from the Top Text Menu - Feature > Boss > Revolve.



- In the **Revolve Boss** popup, change the **Label:** to Globe-Revolution<1>.



- Click in the selection for 'Axis:', Select the Vertical Axis - the 'Y-Axis'.

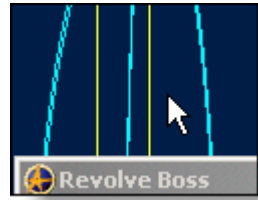
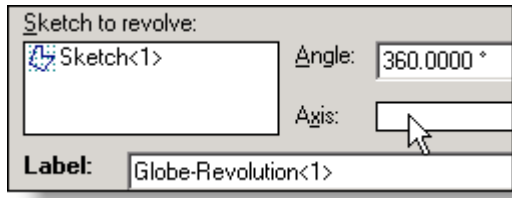

- Notice the Preview Revolve Steps. Click 'OK'. There is your Globe!

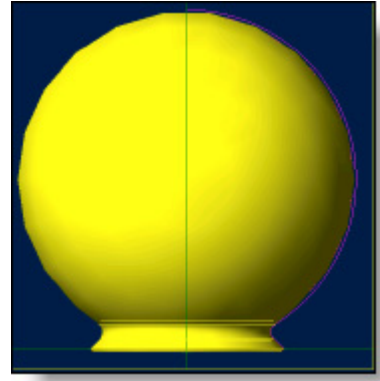
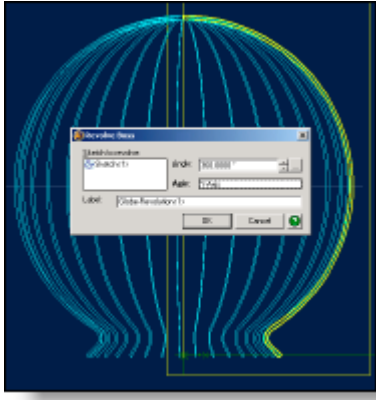

- Select **Zoom to Fit**. Click. This Centers the Globe in the Part Window.



Notice the Globe Has a Faceted or Flat Spot series of edges. To correct this, Adjust Curve Smoothness.

Select **File > Properties**. (Note the keyboard shortcut: **Alt+Enter**) Select the Tab "**General**"

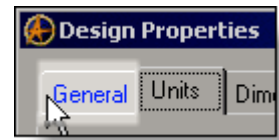
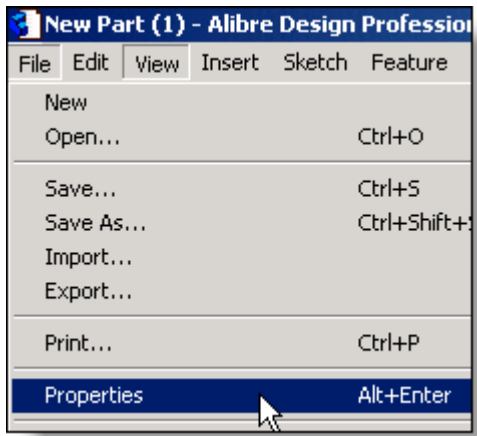

- In Curve Smoothness, Select the 'Manual' Radio Button, Change 'Minimal Circular Facets:' Edit 18 to become 48. (Highlight <click-drag> 18, type in 48)

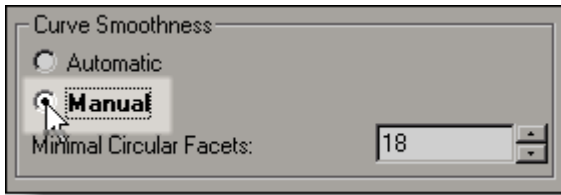

- Click Apply. Notice the Ball Surface become Smoother. Click 'Close.'



To Finish the Special Touches:

- Select from the Top Text Menu, **Edit > Color Properties >**

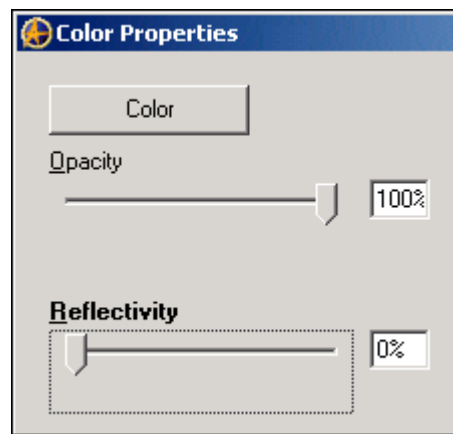
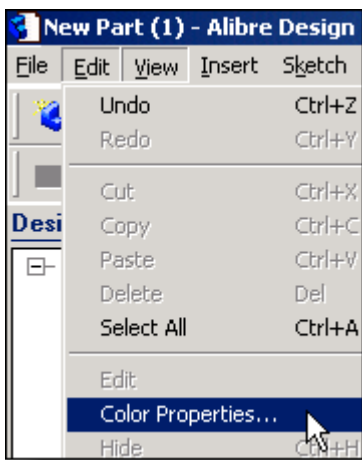

- Use the Mouse to move the Slider or edit the 0% in **Reflectivity**, and change it to 10%. (Click the mouse once on the right side of the slider button to move it 10%)



- Click on the **Color** Button, >

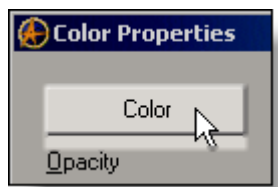

- Select the White Square in the lower right corner of the **Basic Colors**. Click 'OK'

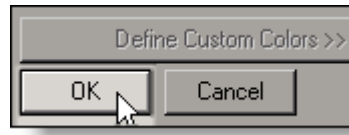

- Select the Opacity 100% and change the 100 to 90, press 'Tab'. Click 'OK'.

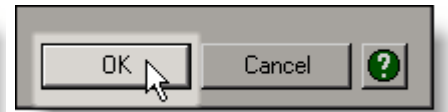
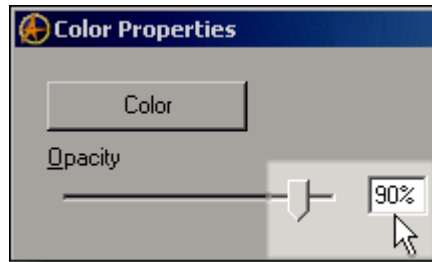
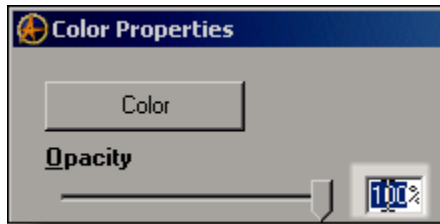

Select - **File - Save As...** (Note the Keyboard Shortcut: **Ctrl+Shift+S**)

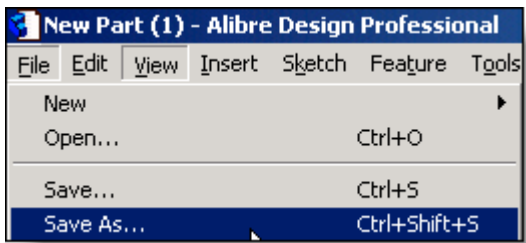

In the **Name:** Field - change 'New Part (1)' to Globe-1. Create a **New Folder** to save this file in, called 'Tutorials'. Slick 'Save'.



To see the Globe in Different Angles, click the mouse in the work area, Press and hold both Left and Right mouse buttons, and move the mouse around to control the viewing position of the part.

Congratulations! You have completed the Translucent Glass Lamp Globe!

(Complete Version)

Give me feedback on this tutorial! [Send email](#)

[If you found this and you don't yet have a copy of Alibre Design - Click this Link for a 30-Day Free Trial Copy!](#)